

# Cross Hatch Garden BBQ Shelter



## Component List

2 x Front Support Posts	3" x 3"	2100mmm	(A1)
2 x Rear Support Posts	3" x 3"	1950mm	(A2)
2 x Roof Framing	2" x 2"	1660mm	(B1)
4 x Roof Rafters	2" x 2"	1260mm (Angle Cut)	(B2)
13 x Featheredge Roof		1800mm	(B3)
2 x Side Fascia Boards	4" x 1"	1350mm (Angle Cut)	(B4)
1 x Front Fascia Board	4" x 1"	1840mm	(B5)
1 x Decorative Front Piece			(B6)
3 x Decorative Crosshatch Panel			(C1)
4 x 32mm Square Spindles			(C2)
3 x Hand / Baserail (Rear)		1660mm	(C3)
6 x Hand / Baserail (Sides)		1200mm	(C4)
95 x 50mm Green Screws			(FIX 1)
16 x 75mm Green Screws			(FIX 2)
20 x 100mm Screws			(FIX 3)

### Recommended Tools

Drill Driver  
PZ2 Driver Bit  
Tape Measure  
Spirit Level

We recommend two people to assemble this BBQ shelter.

# Cross Hatch Garden BBQ Shelter

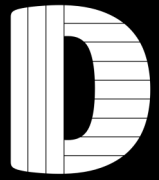

## Step 1

*\*To prevent splits, drill a pilot hole before driving screws\**

To create the rear panel, assemble parts (C1), (C2) and (C3) as per below, use 50mm green screws (FIX 1) as indicated to join the pieces together.

The panel should be approximately 270mm in from either end to be centred.

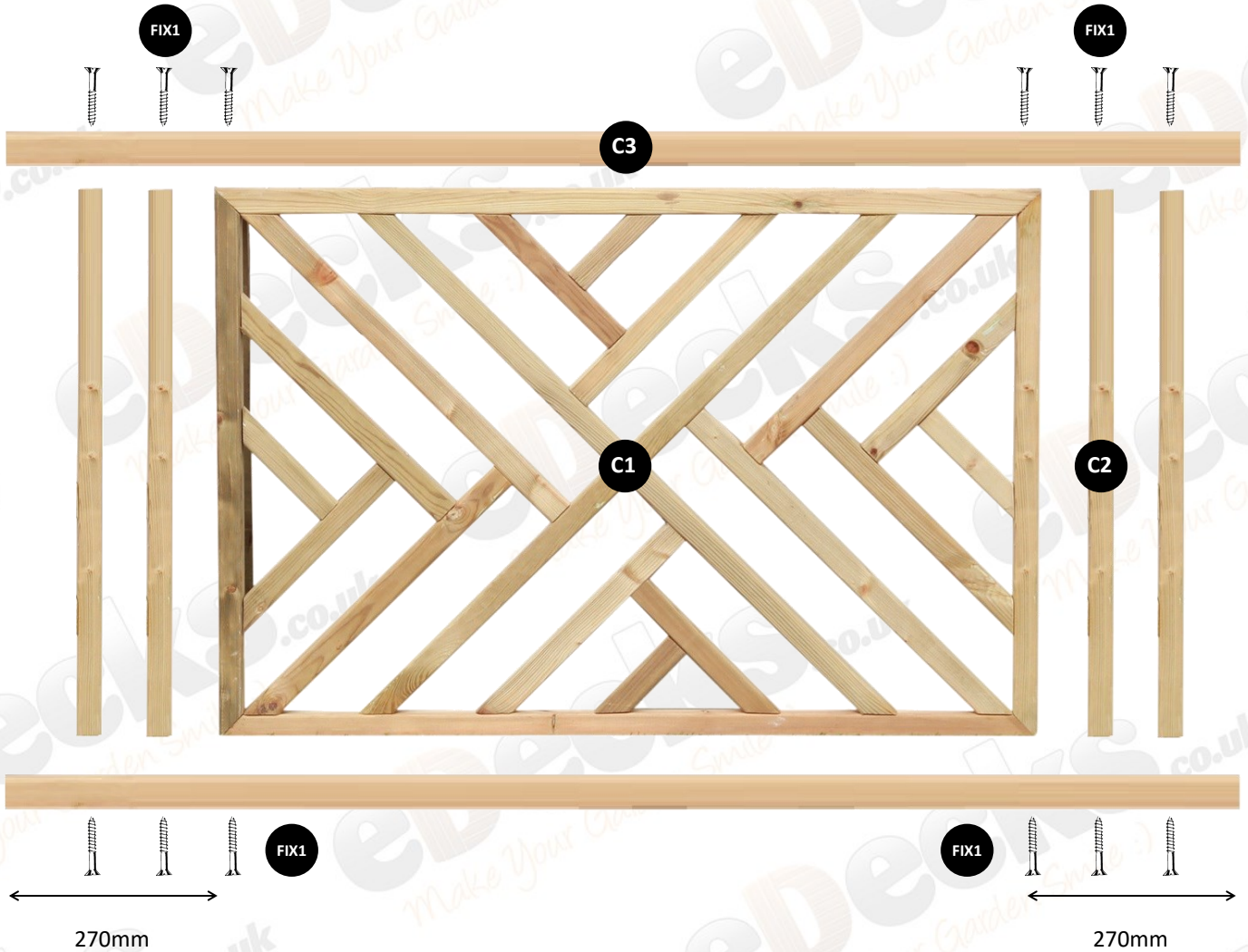

All Hand / Baseraills all to be installed this way up to stop any water collection in the groove underneath.



All images are for illustration only. Please see individual item listings for actual item specifications.

# Cross Hatch Garden BBQ Shelter

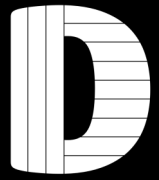

## Step 2

*\*To prevent splits, drill a pilot hole before driving screws\**

To create the side panels, assemble parts **(C1)** and **(C4)** as per below, use 50mm green screws **(FIX 1)** as indicated to join the pieces together.

The panel should be approximately 35mm in from either end to be centred.

Repeat the process for both sides.

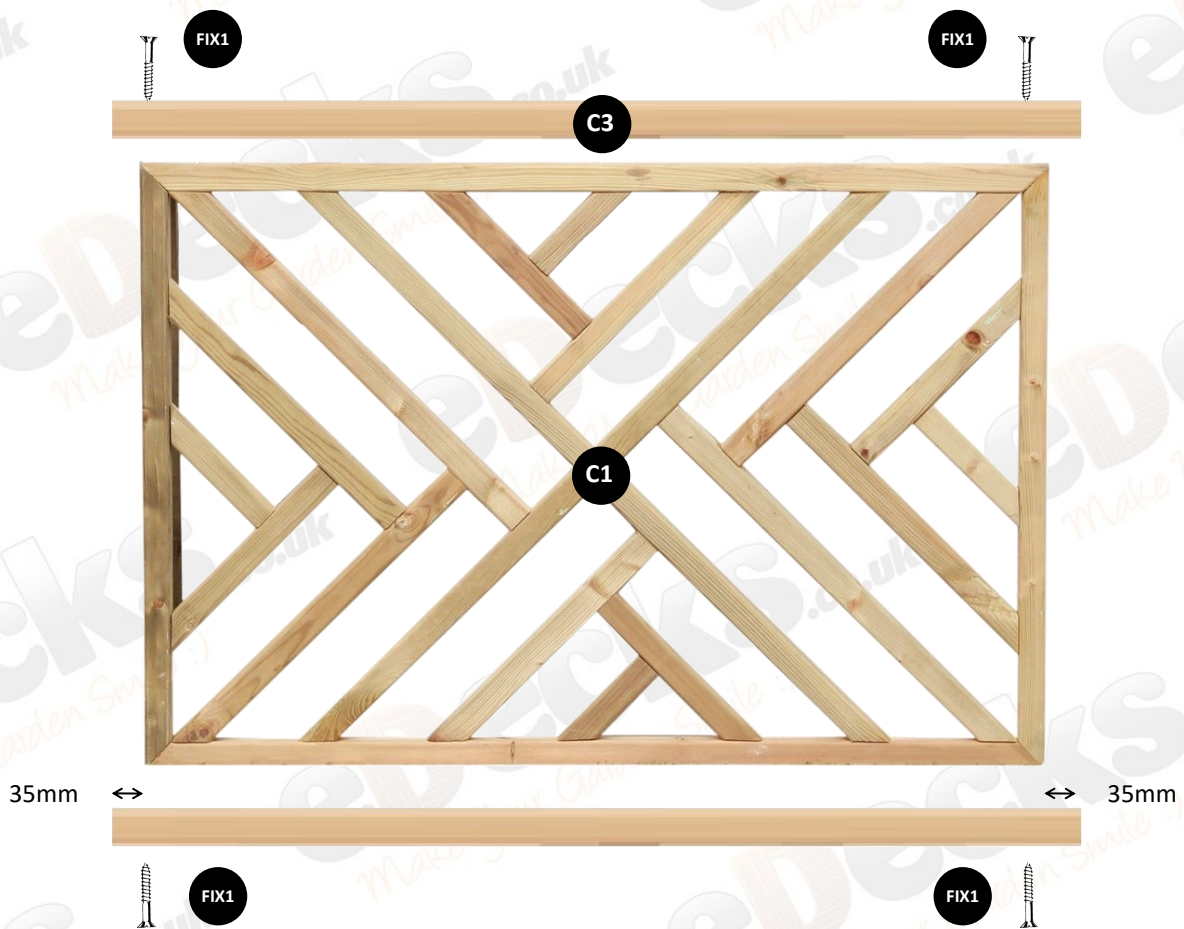

All Hand / Baseraills all to be installed this way up to stop any water collection in the groove underneath.



All images are for illustration only. Please see individual item listings for actual item specifications.

Page 3 of 10



# Cross Hatch Garden BBQ Shelter

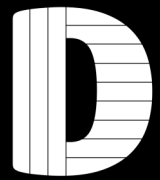

## Step 3

*\*To prevent splits, drill a pilot hole before driving screws\**

With the three side/rear panels now built, they can be attached to the corner support posts.

Starting with the rear support posts (**A2**) place the rear panel between the two posts and screw into place using 2 x 100mm screws (**FIX 3**) per side, driving through the post from the outside, one at the top and one at the bottom.



## Step 4

With the rear section fixed in place, both sides can be then screwed into position as per the diagram to the right, we recommend approx. 270mm from the floor to give a comfortable handrail height but this is at your personal discretion.

The fixing method is the same as step 3, using 2 x 100mm screws (**FIX 3**) one at the top and one at the bottom on each side, through the posts into the hand / baserails.

We recommend first fastening the side panel to the rear support post (**A2**) before moving onto the front support posts (**A1**).

Repeat the process on both sides.



# Cross Hatch Garden BBQ Shelter

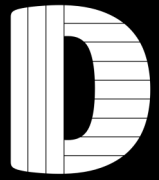

## Step 5

*\*To prevent splits, drill a pilot hole before driving screws\**

Using the roof framing parts **(B1)** and **(B2)** assemble your roof frame as below.

Screw through the face of **(B1)** into the rafters / frame timbers **(B2)** using 2 x 75mm green screws **(FIX 2)** at each end.

**Please Note:** Due to the slight angle cuts on pieces **(B2)** the frame should not lay flat; this is to create the sloping pitch on the roof which will allow for water to run off the back.

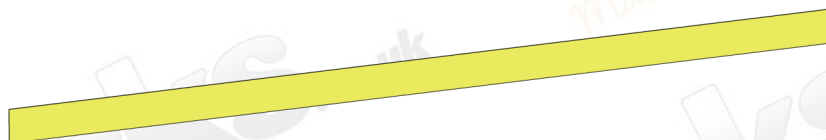
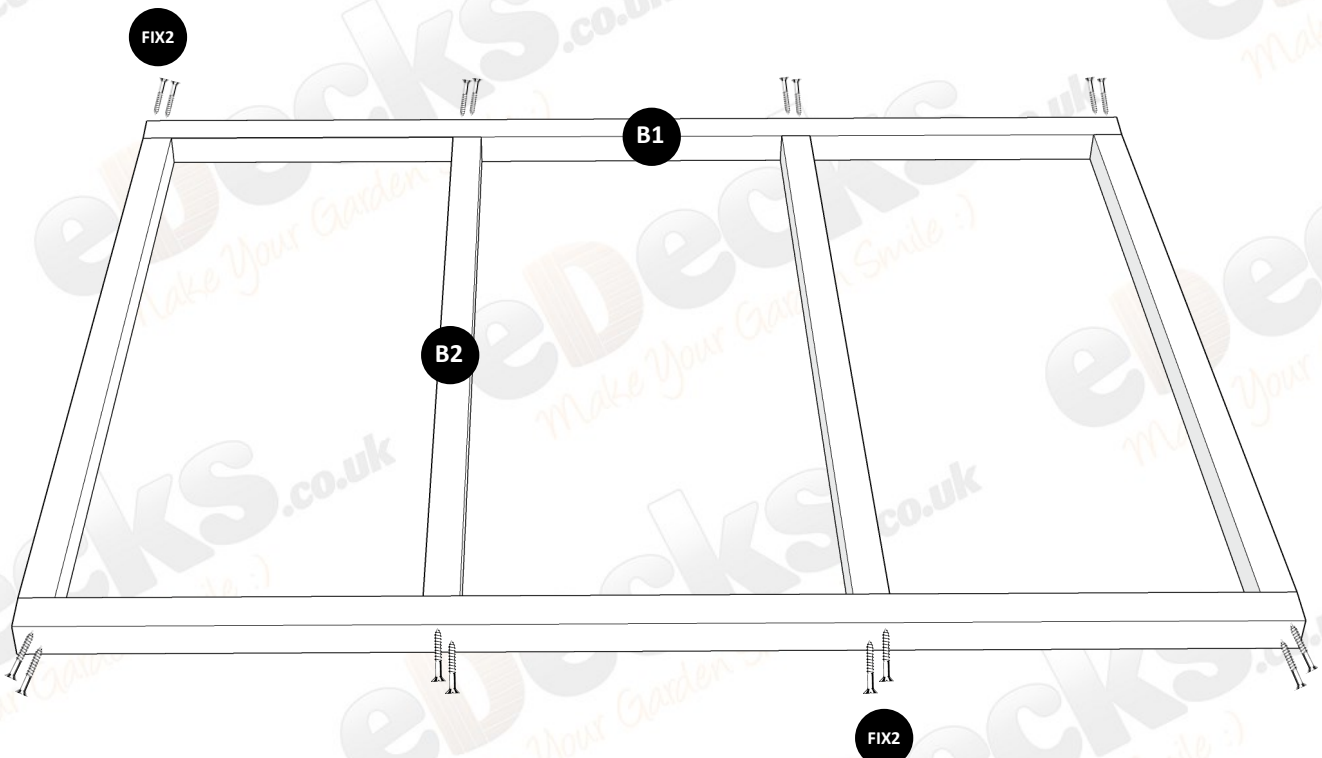

**(B2)** Side Profile

All images are for illustration only. Please see individual item listings for actual item specifications.

# Cross Hatch Garden BBQ Shelter

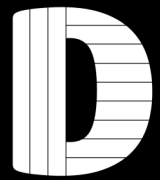

## Step 6

*\*To prevent splits, drill a pilot hole before driving screws\**

Attach the featheredge roof boards (**B3**) to the roof frame you have just built in step 5 using 1 x 50mm green screw (**FIX1**) per board, per joist as indicated to the right.

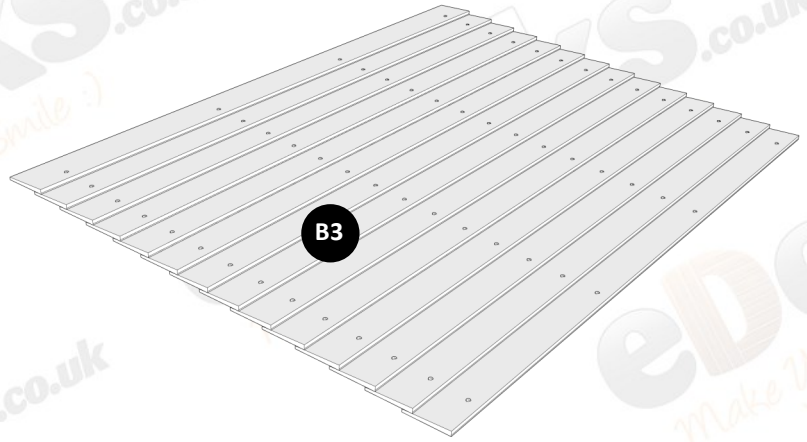

Remember to leave a minimum of 15mm overlap on each board and to screw through the thick part of the featheredge board.

The featheredge boards should sit flush at both the front and rear but will overhang the frame at both sides by 70mm.

See below for underside view.

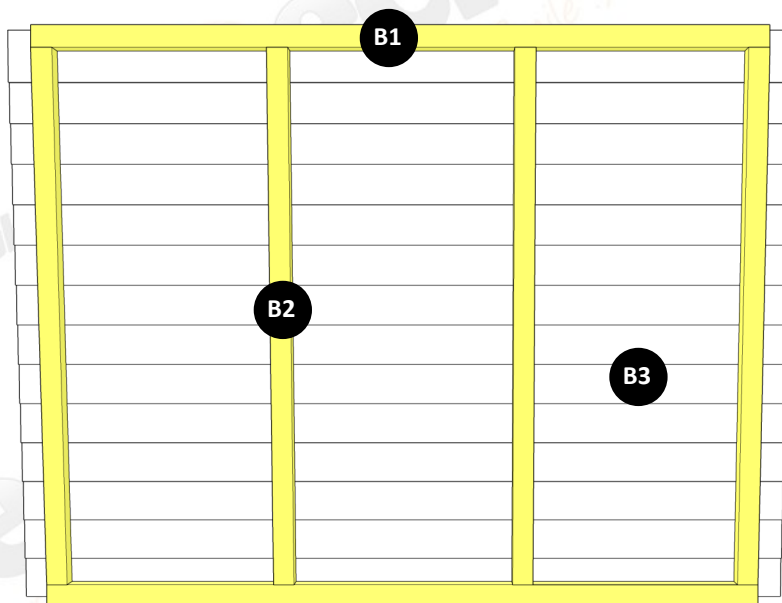

All images are for illustration only. Please see individual item listings for actual item specifications.



# Cross Hatch Garden BBQ Shelter



## Step 7

*\*To prevent splits, drill a pilot hole before driving screws\**

Lift the roof above the corner posts and rest it in place, the outer edges of the roof frame should sit inside the posts.

Fix the roof in place using 2 x 100mm wood screws (**FIX 3**) per corner driving through the posts from the outside.

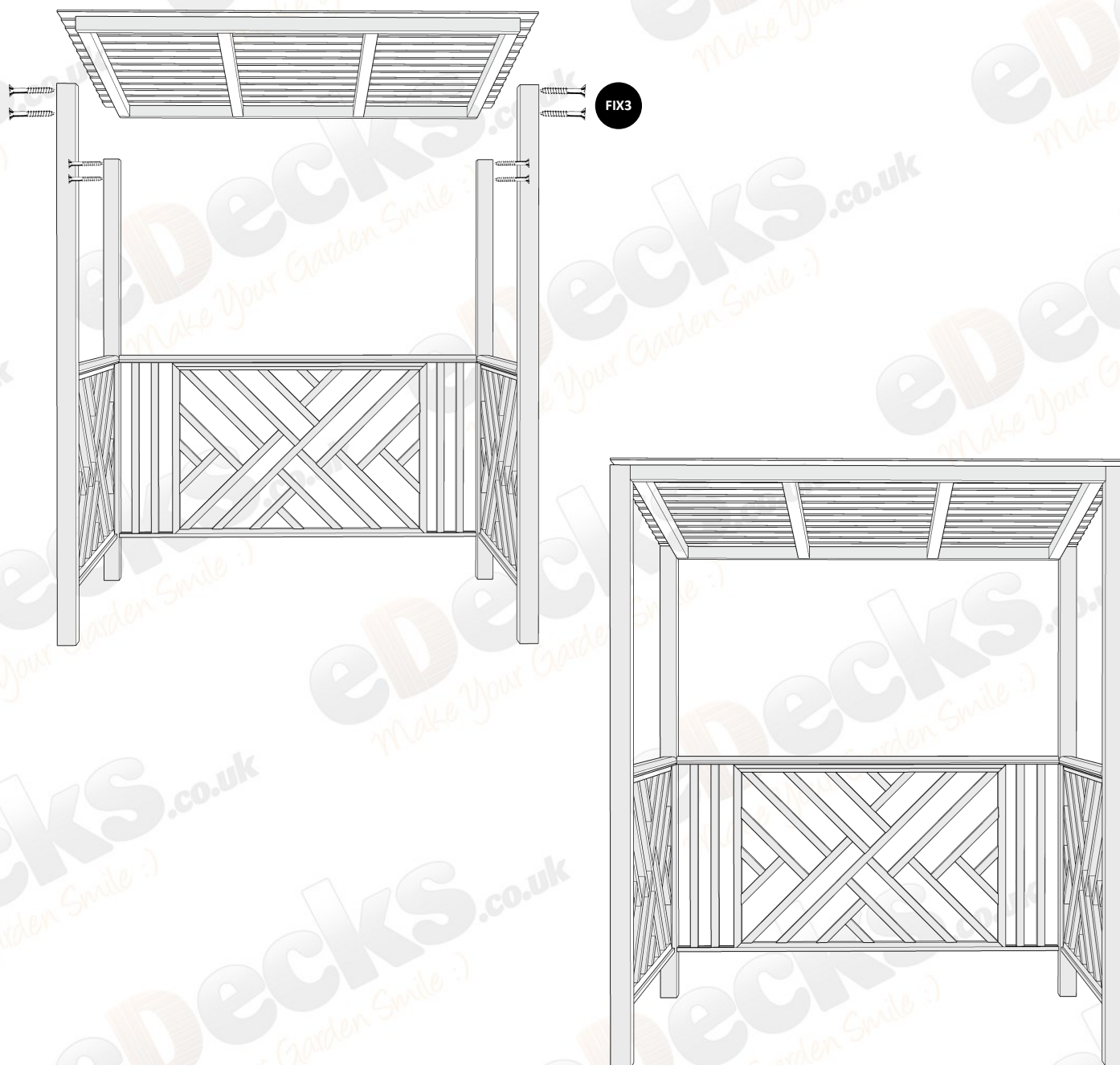

# Cross Hatch Garden BBQ Shelter

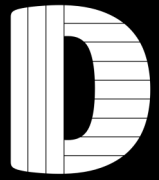

## Step 8

*\*To prevent splits, drill a pilot hole before driving screws\**

With the roof fixed in place the fascia boards (**B4**), (**B5**) and the decorative piece (**B6**) can now be installed to finish off the roof section.

The fascia's are fastened into place using 4 x 50mm green screws (**FIX 1**) as below.

The decorative piece is to be centred on the fascia and fixed in place by screwing through the back of the frame into the piece using 1 x 50mm green screw (**FIX 1**).

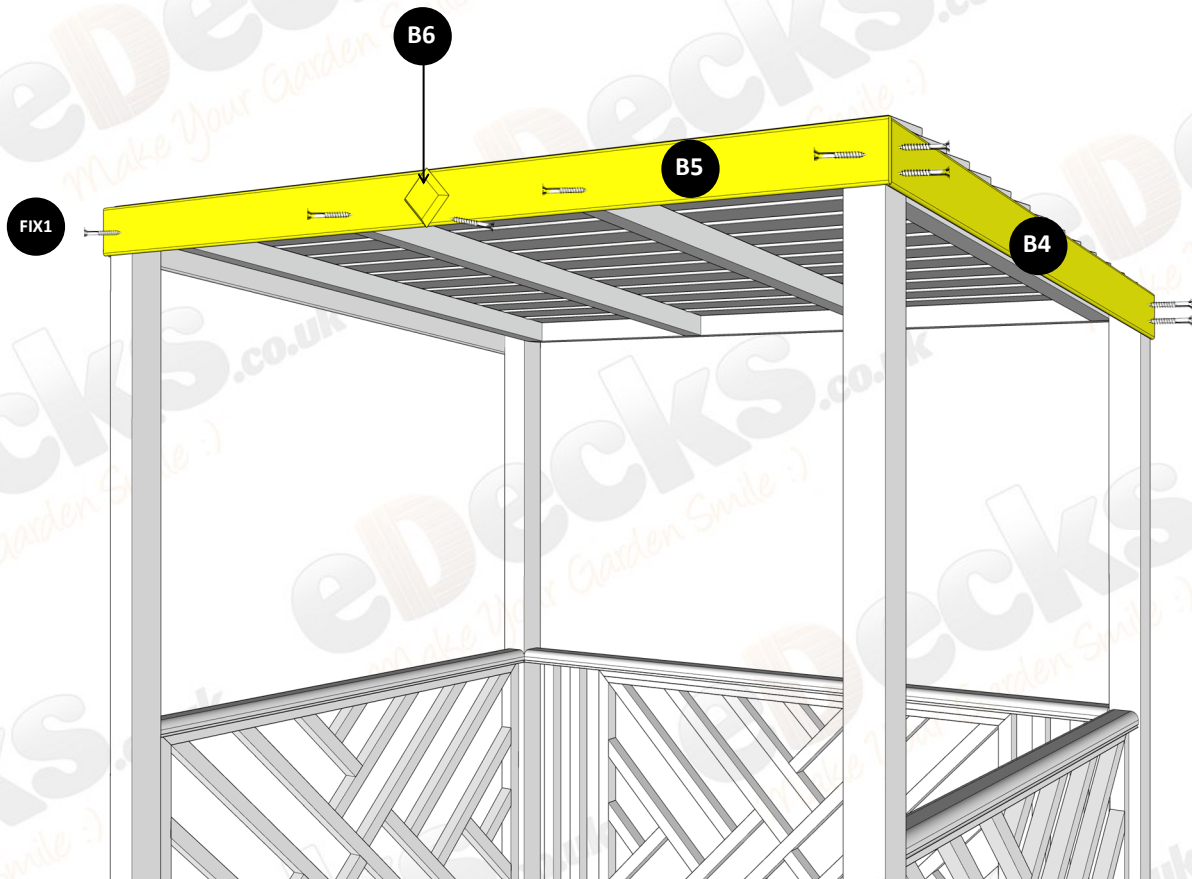



# Cross Hatch Garden BBQ Shelter



## Step 9

*\*To prevent splits, drill a pilot hole before driving screws\**

To complete the build, you lastly have to install the side and rear handrails (**C3**) and (**C4**) which double up to create a more solid feel and cover any screw holes made in earlier steps.

These should sit flush in-between your corner posts and are secured using 1 x 50 green screw (**FIX 1**) at each end, the screws should be driven up through the bottom handrail into the other (**C3 / C4**) sitting on top.

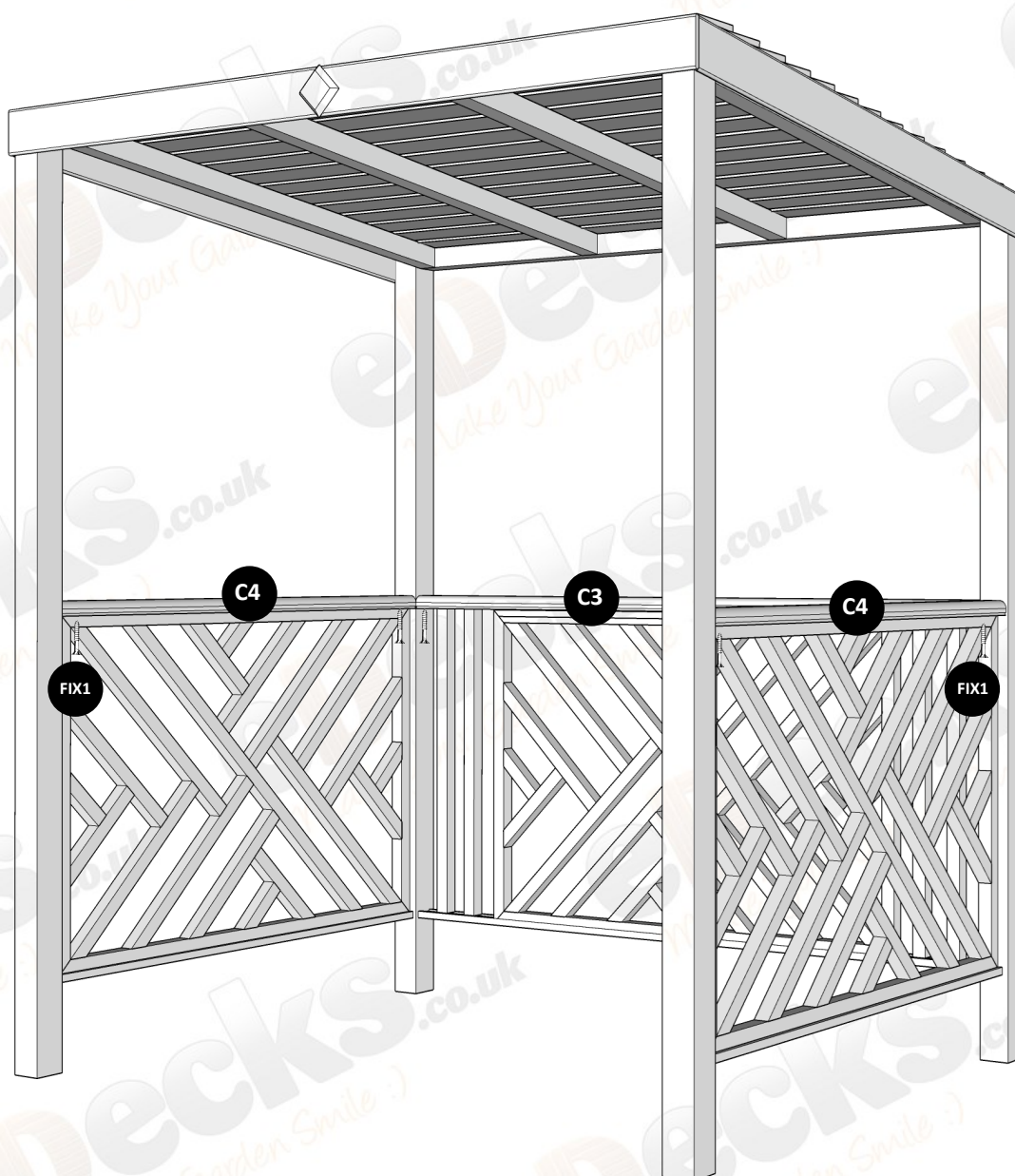

All images are for illustration only. Please see individual item listings for actual item specifications.

Page 9 of 10



# Cross Hatch Garden BBQ Shelter



**Enjoy your new BBQ Shelter!**

All images are for illustration only. Please see individual item listings for actual item specifications.

Page 10 of 10