

Queen Anne Fitting Instructions



Step 1

LAY YOUR FRAME

Lay out your decking frame in your chosen location on the ground

**FRAME TO BE LAID ONTO
PAVING SLABS, OR ONTO
GRASS OR SOIL**



This may require
some cutting to fit your size
requirements

Using the decking joists provided in the kit build the perimeter first then evenly spread the remaining decking joists inside as shown in the example above.

Use the joist screws provided in your fixing kit to secure the timbers as per method below.

METHOD FOR SCREWING JOISTS

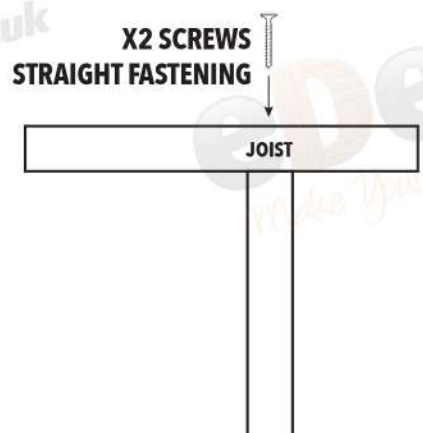
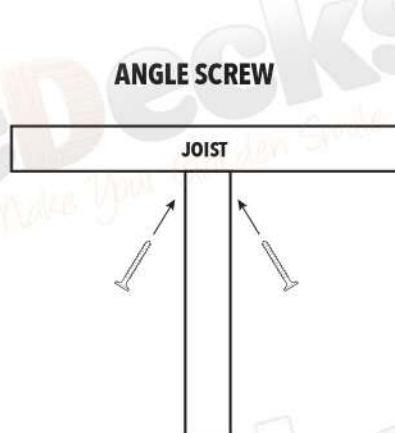
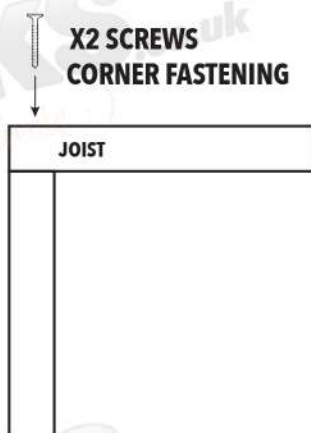

JOISTS TOP VIEW

Please make sure the frame fits the requirements for your chosen kit.

Don't forget to check your work with a level as you go!

Step 2

RAISING THE FRAME

A. Arrange the 600mm deck raisers in position as shown in diagram A

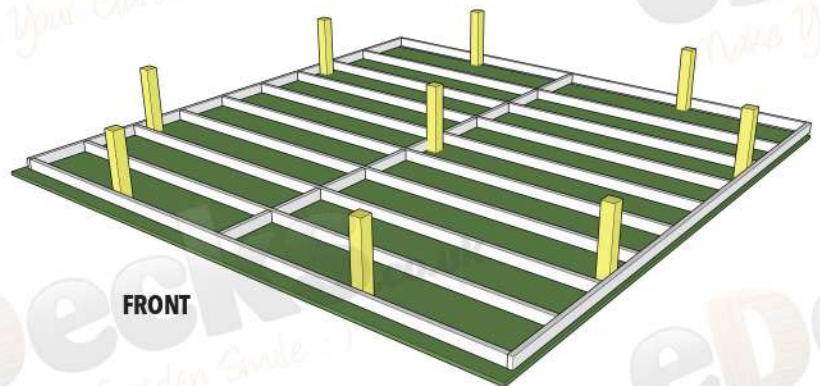

B. Each strutt will need to be set 200mm down into a concrete base leaving 400mm of each strutt exposed

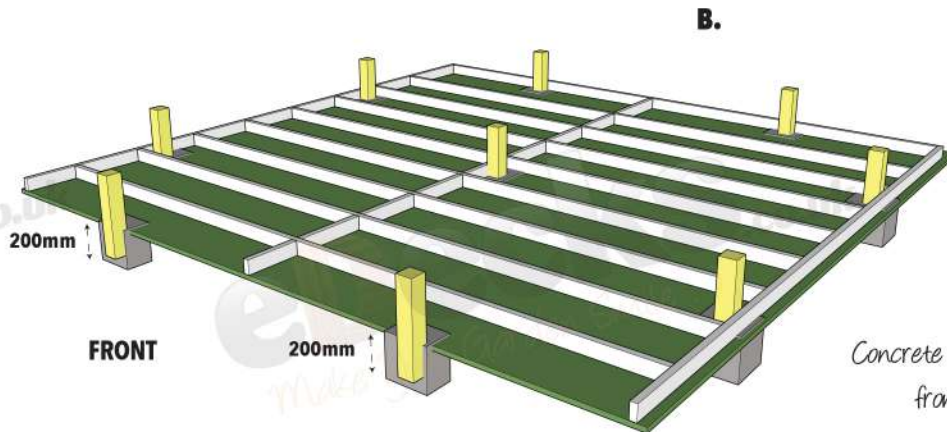

Concrete can be bought from us too!

C. Once raising struttis are securely set in concrete base lift the assembled joist frame to be level with the struttis (400mm). Using the screws provided fix the frame to the struttis.

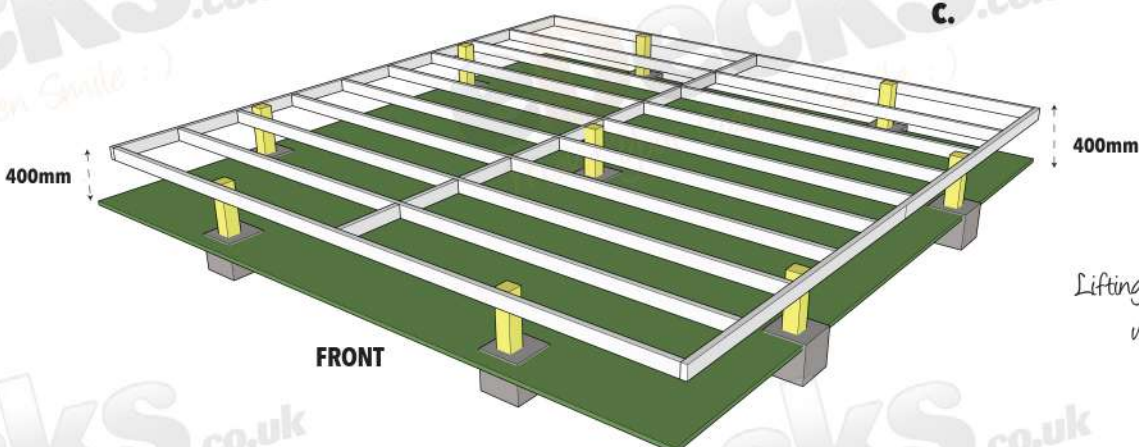

Lifting the frame into position will require at least 2 - 3 people

Don't forget to check your work with a level as you go!

Step 3

FITTING THE PERGOLA POSTS & NEWELS

You are supplied with pergola posts and newels. Accounting for the post sitting flush with the bottom of the base please select how high you would like the pergola posts, please cut accordingly.

Each Pergola Post needs securing in each corner and depending on the size of the kit posts may need fitting in between.

Install posts and newels so your kit begins to look like the below...

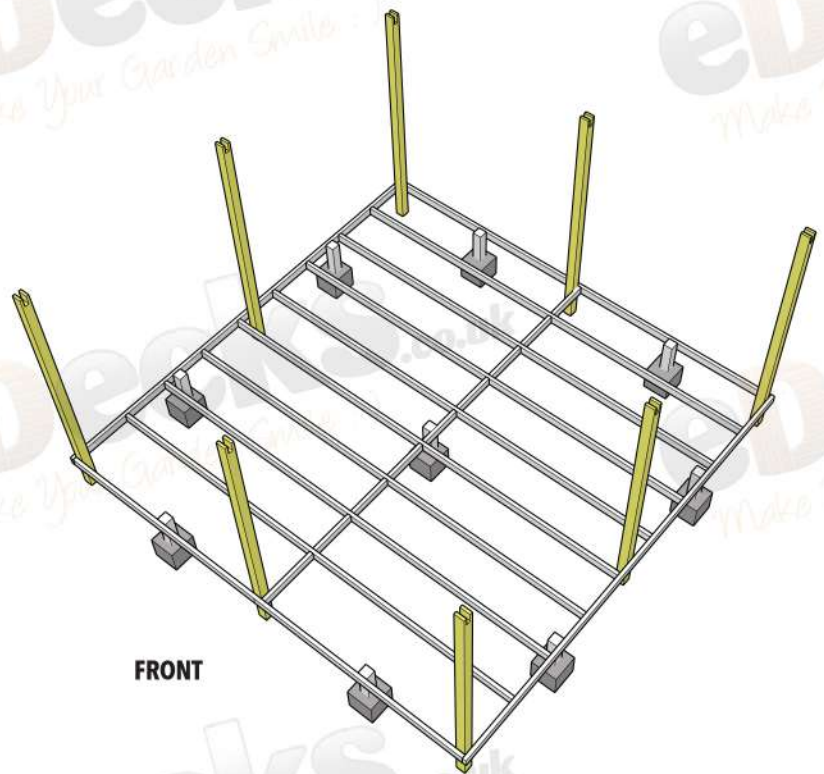

Please make sure your post notches line up

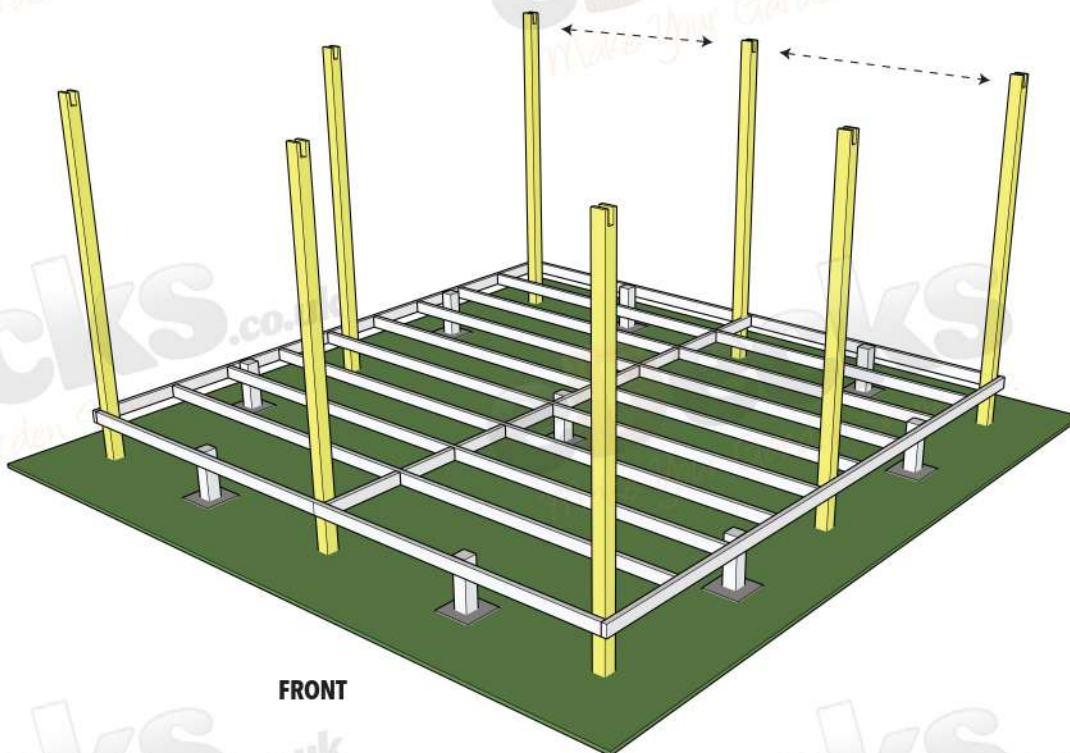

A. SECURE AT CORNER

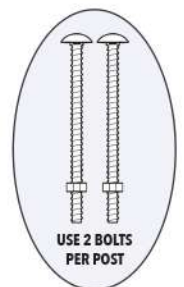
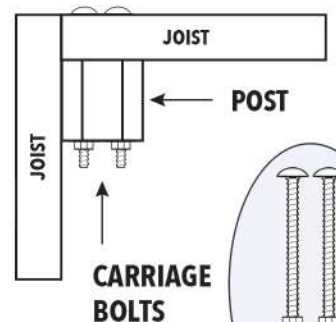

B. SECURE AT SIDE

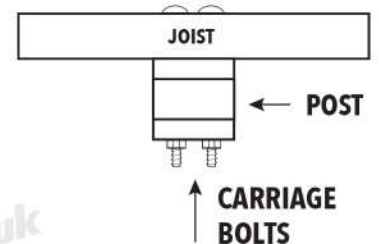

Don't forget to check your work with a level as you go!

Step 4

FITTING THE STRINGER STEPS

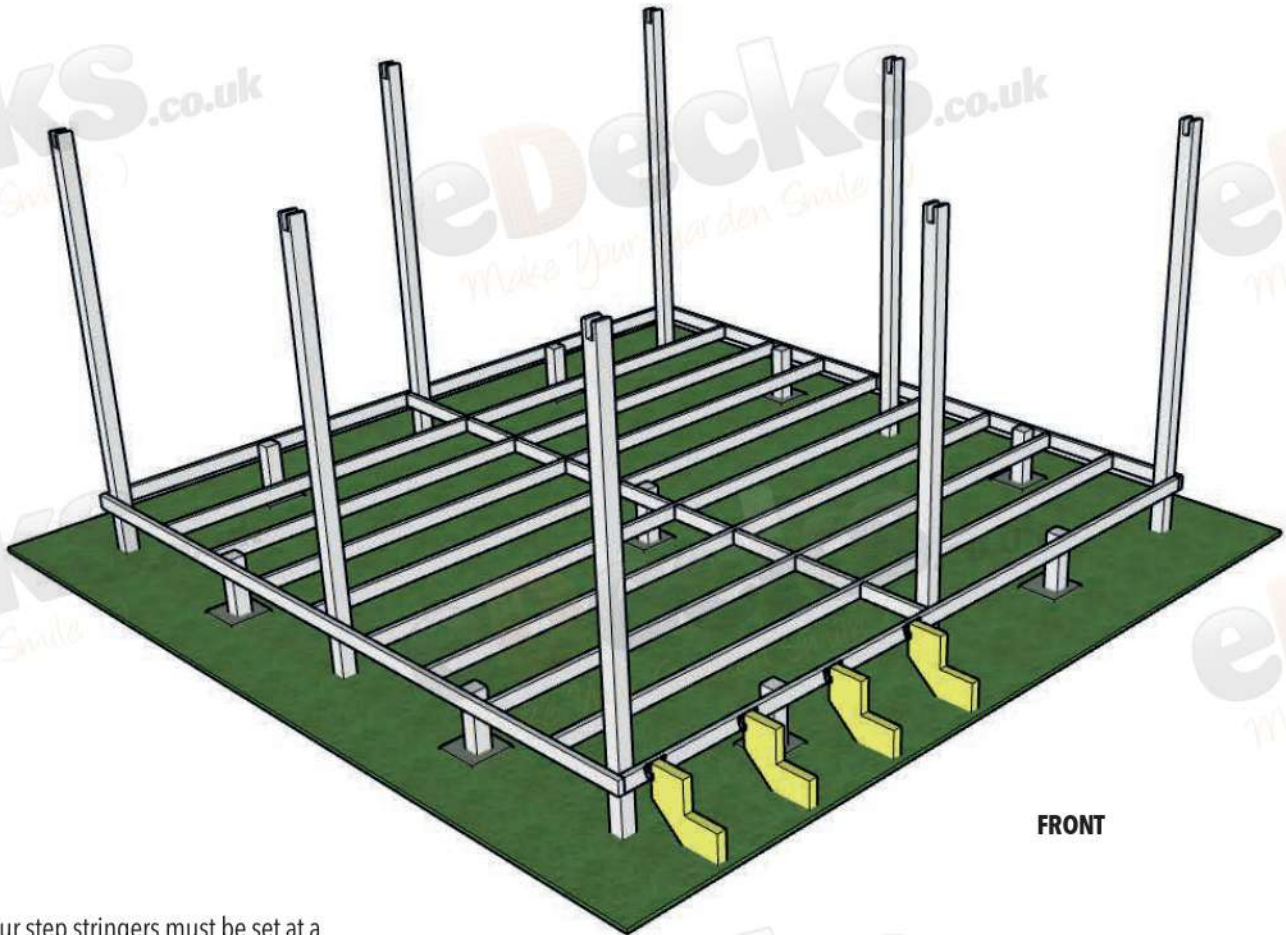

Your step stringers must be set at a maximum of 600mm apart

Use the 50mm truss clips included with your kit to attach the step stringers to the decking frame

Screw into the front of your deck joist

Don't forget to check your work with a level as you go!

Step 5

INSTALL DECKING BOARDS

Decking boards should fit exactly to the frame, working in the opposite direction to the joist work, when laying the boards make sure you leave a 5mm gap between each board to allow room for expansion.

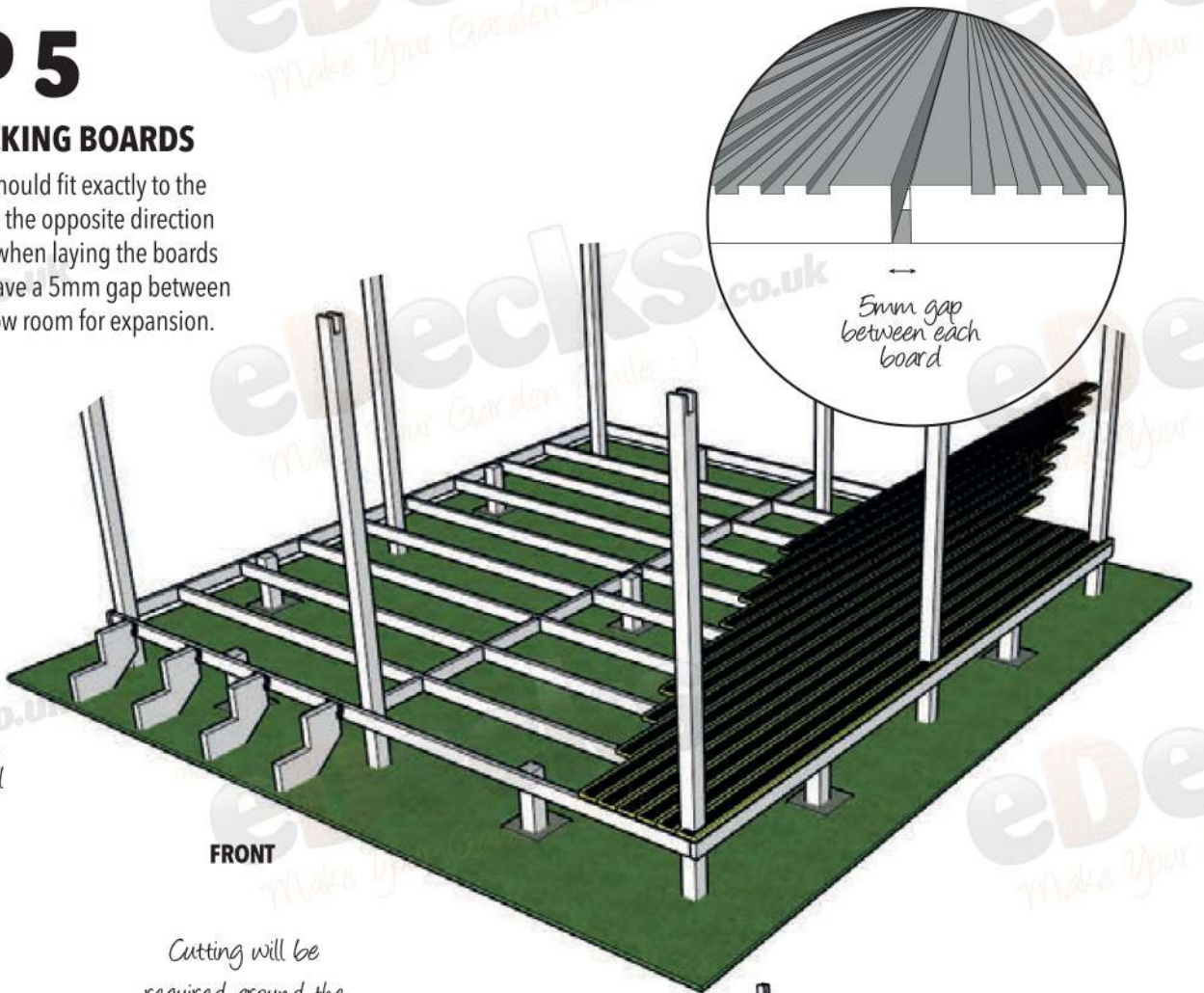

2 screws per board per joist

Cutting will be required around the Posts

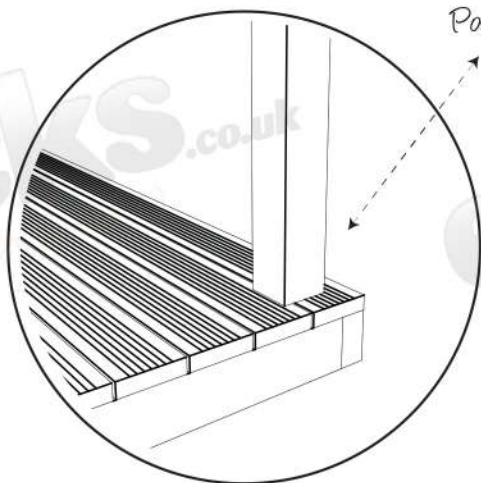

Don't forget to check your work with a level as you go!

Step 6

INSTALL DECKING BOARD STEPS

Run the boards for the steps in the opposite direction to the boards for the deck, some cutting down the length of these boards will be required to work around the step and riser of the 4 stringers installed in step 4.

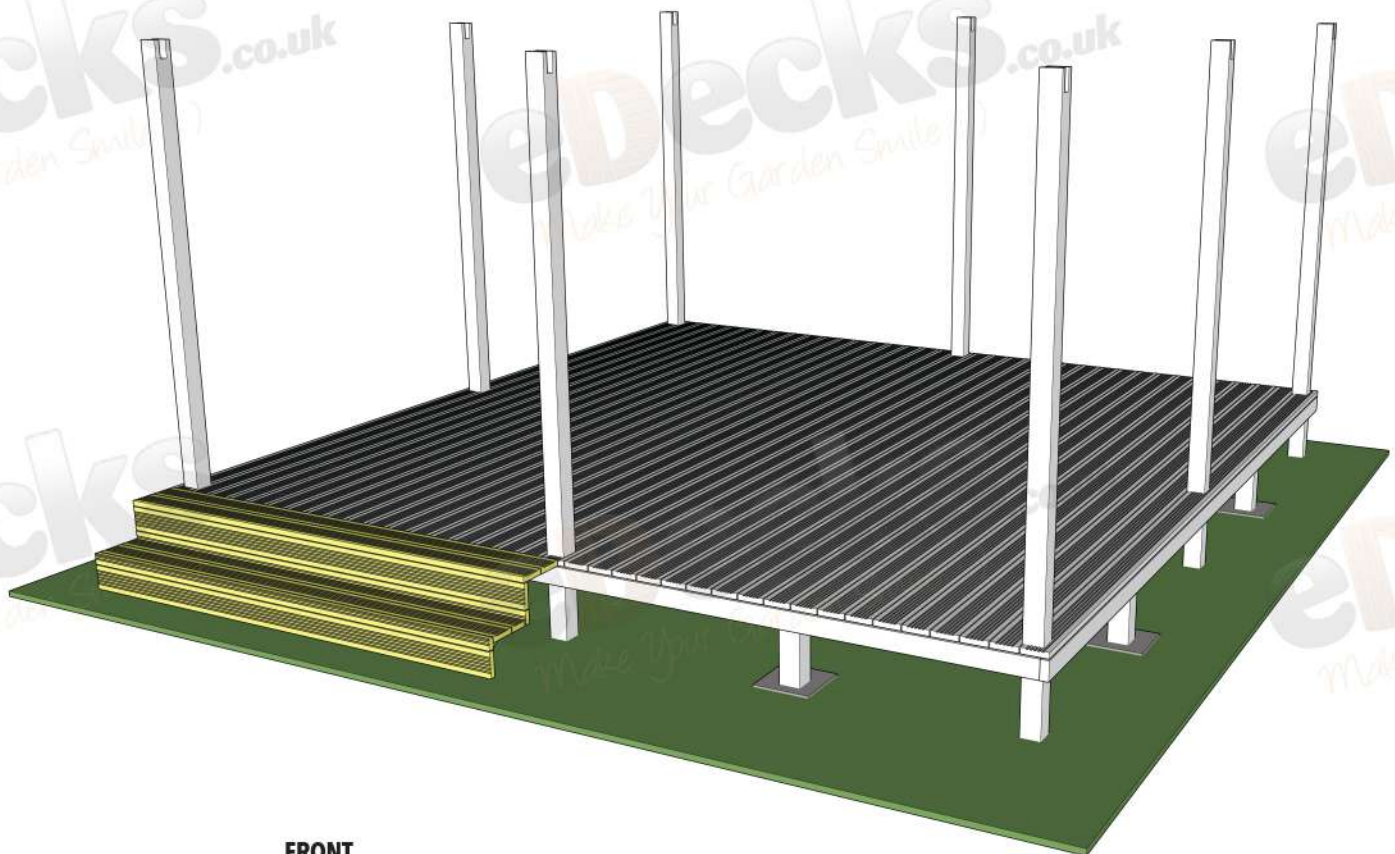
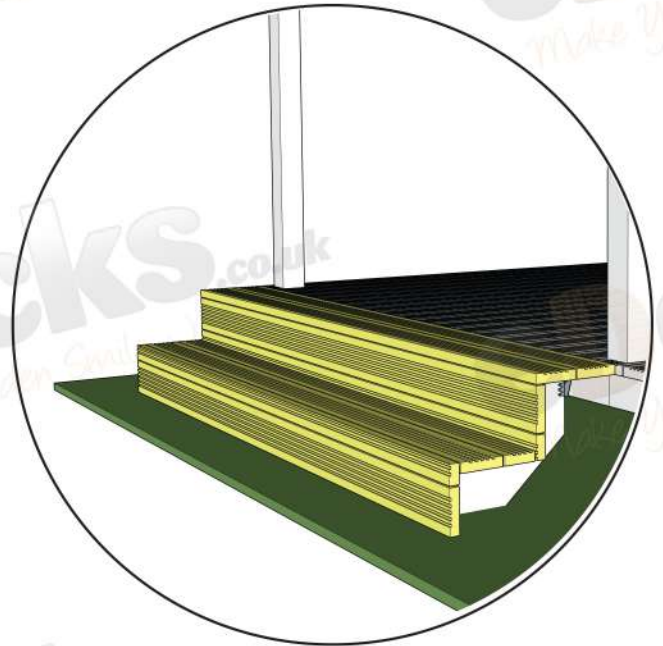

FRONT

Don't forget to check your work with a level as you go!

Step 7

INSTALL FASCIA BOARDS

Cutting will be required for the fascia boards surrounding the steps.



FRONT

Don't forget to check your work with a level as you go!

Page 7 of 13

All images are for illustration only, Please see individual item listings for actual item specifications

Step 8

INSTALL SUPPORT RAFTERS

First secure the 3 supporting rafters to the posts.

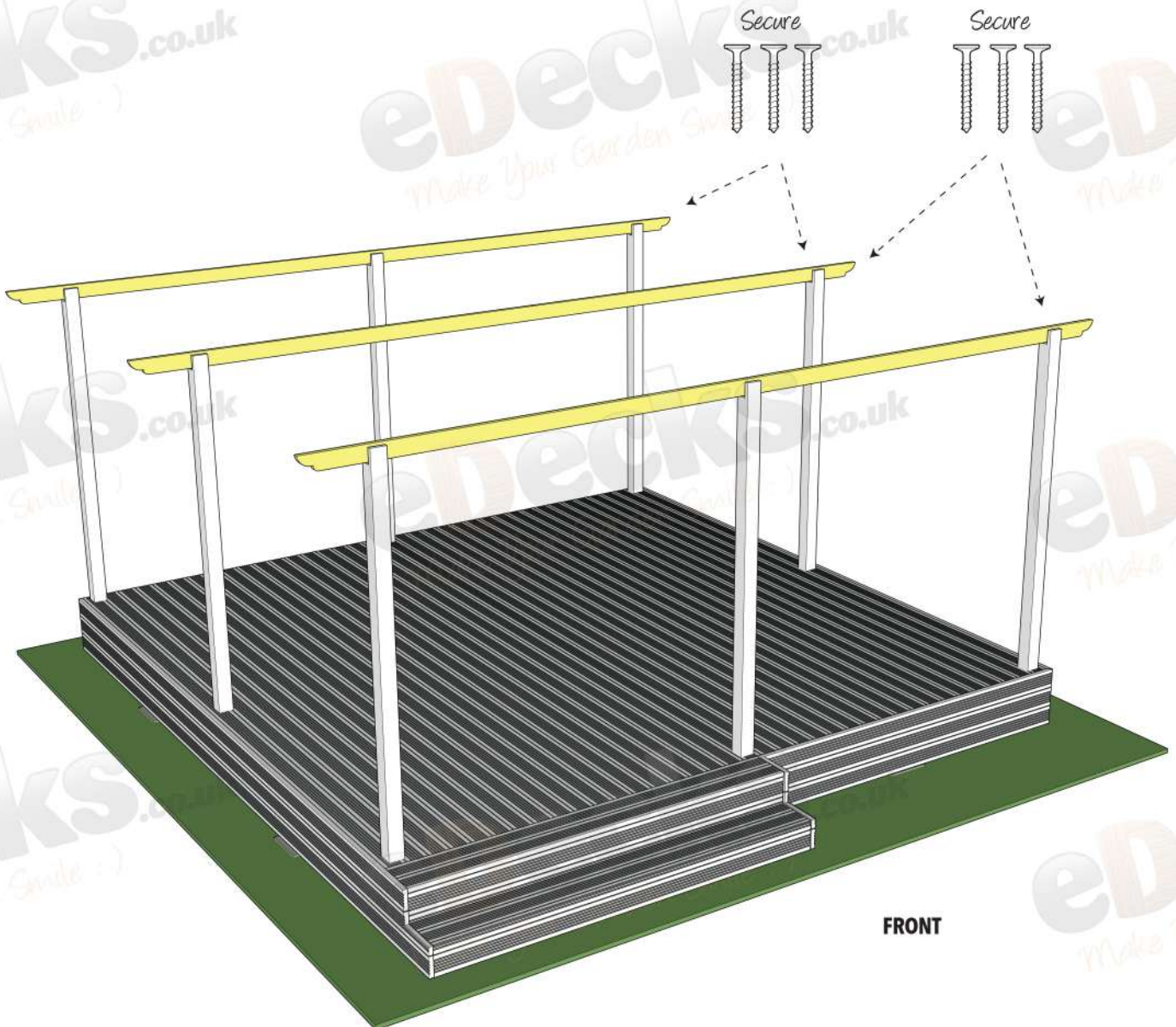

Don't forget to check your work with a level as you go!

Page 8 of 13

All images are for illustration only, Please see individual item listings for actual item specifications

Step 9

INSTALL RAFTERS

Space the remainder of the rafters across the top of the support rafters

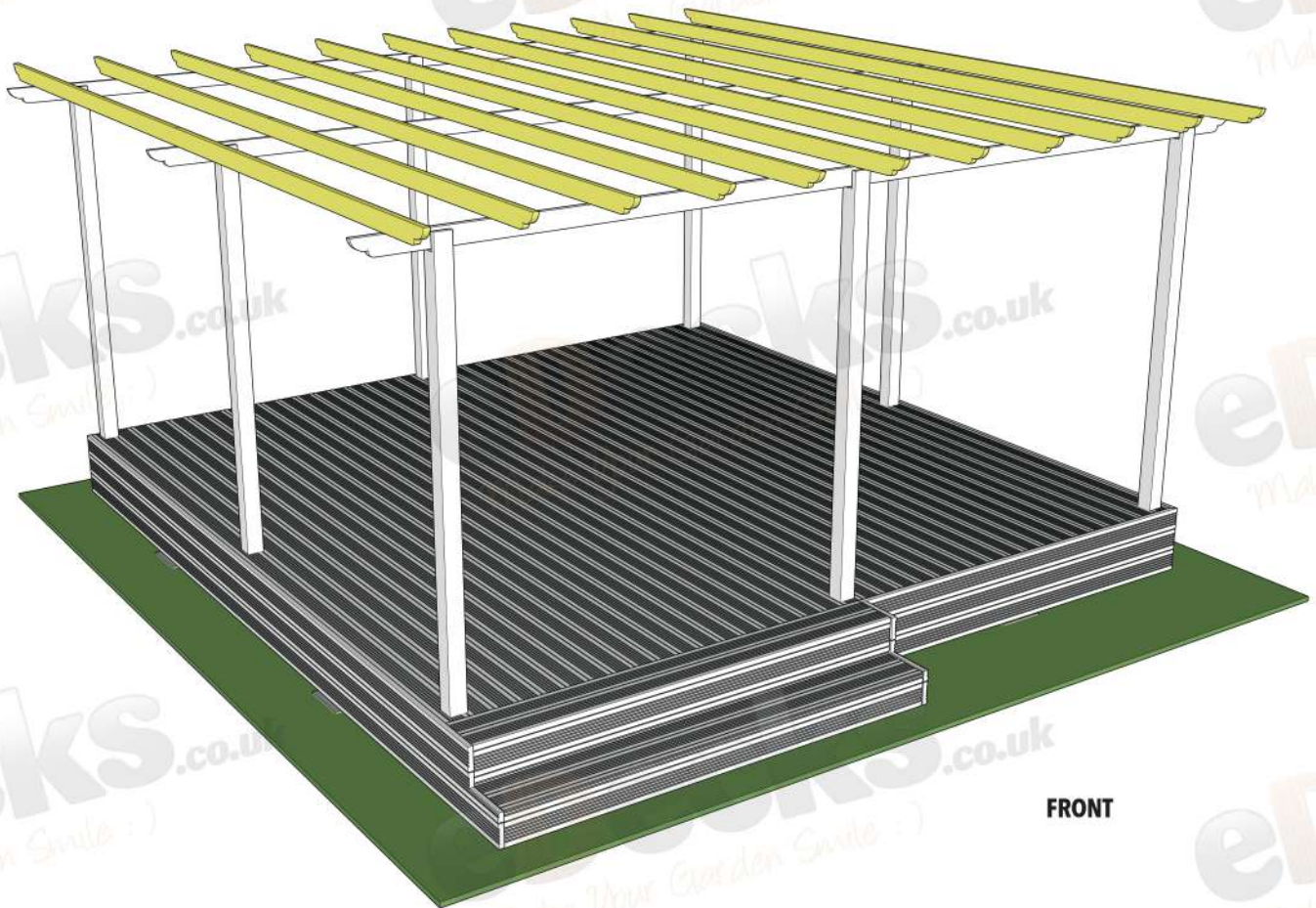

FRONT

Using the Pergola Clips
Provided with your kit
to secure

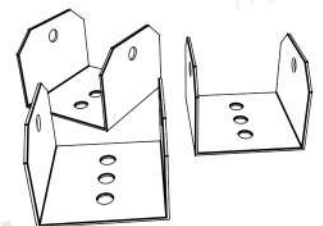

Don't forget to check your work with a level as you go!

Step 10

INSTALL DIAGONAL CROSS SUPPORTS

Attach the 6 supports as shown in the diagram below



Don't forget to check your work with a level as you go!

Page 10 of 13

All images are for illustration only, Please see individual item listings for actual item specifications

Step 11

INSTALL THE HANDRAILS

Pre-Building the spindles and handrails is the next step. Accurately measure between pergola posts and cut the hand and base rails accordingly, there should be a 125mm gap between each spindle

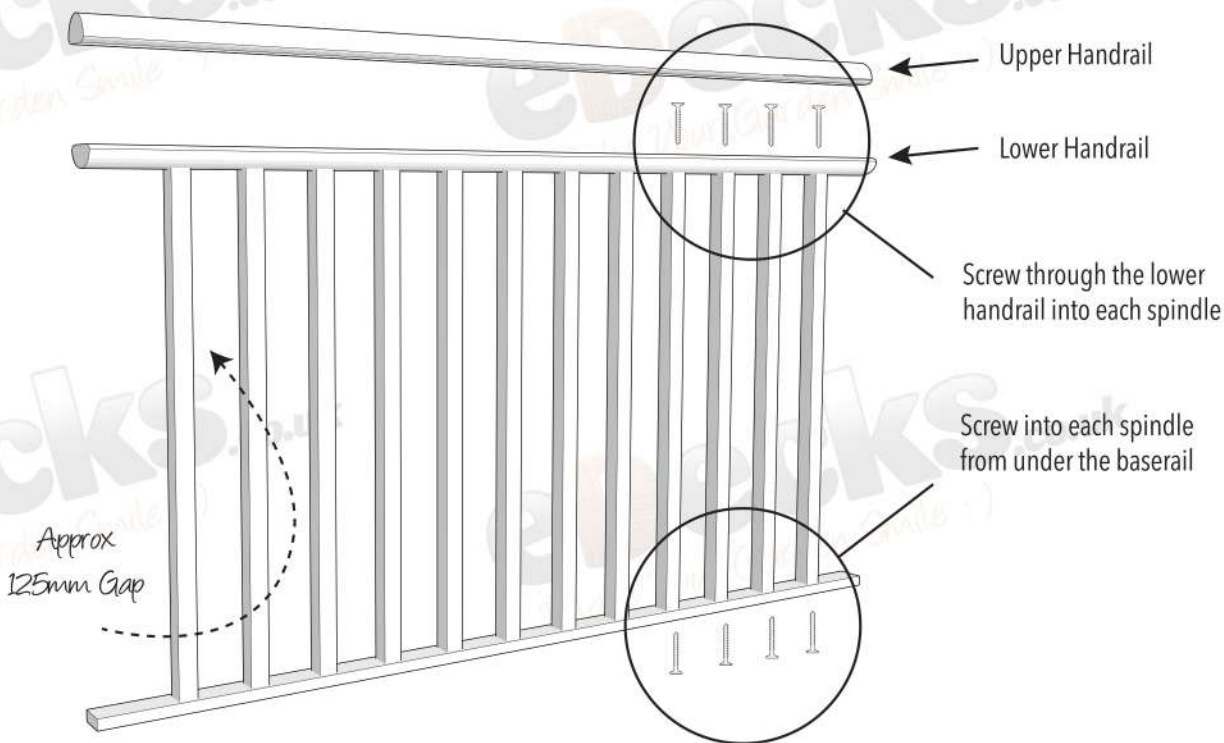

Then complete the handrail section by fixing the upper part of the handrail to the lower part of the handrail

Do this by screwing up through the underside of the lower handrail into the top part of the handrail

Don't forget to check your work with a level as you go!

Step 11 Cont'd

INSTALL THE HANDRAILS

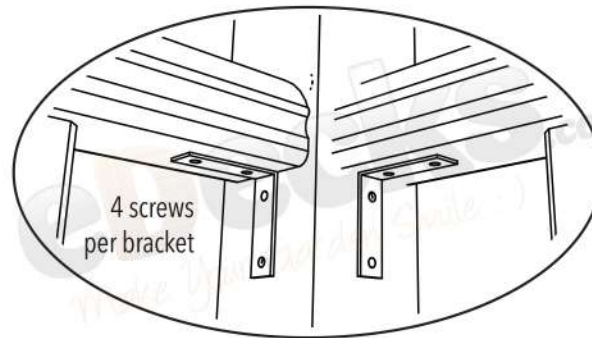

Once your handrail sections are complete - using angle brackets please proceed to install to the kit



Once this is complete - Sit back and enjoy!

Page 12 of 13

All images are for illustration only, Please see individual item listings for actual item specifications

Step 12

FINISH!

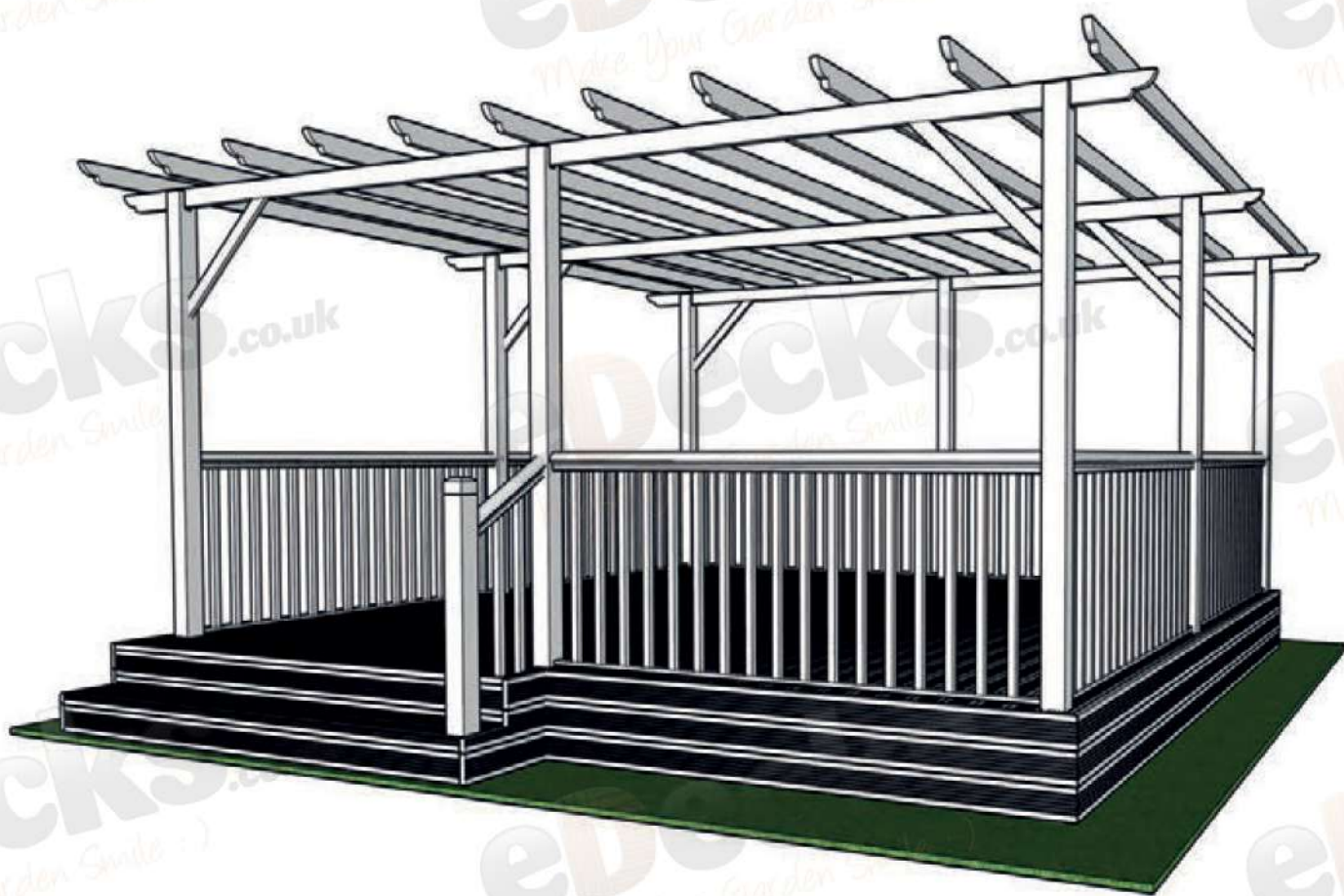

Once this is complete - Sit back and enjoy!

Page 13 of 13

All images are for illustration only, Please see individual item listings for actual item specifications