

THE GRANGE Garden Bar

Fitting Instructions

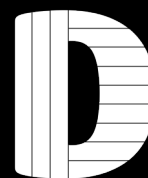

Component List

Supporting Frame

2 x Bar Front 2x2 Posts 2100mm	(A)
1 x Bar Front Roof Support 2x2 1410mm	(B)
1 x Bar Front Floor Support 2x2 1410mm	(C)
2 x Angled/Profiled Decorative Supports 200mm	(D)
2 x Bar Rear 2x2 Posts 1950mm	(E)
1 x Bar Rear Roof Support 2x2 1410mm	(F)
1 x Bar Rear Floor Support 2x2 1410mm	(G)
1 x Open Side Bar Support 2x2 290mm	(H)
1 x Open Side Shelf Support 2x2 290mm	(I)
1 x Open Side Vertical Support 2x2 1050mm	(J)
1 x Open Side Floor Support 2x2 920mm	(K)
1 x Open Side Roof Support Rafter 2x2 920mm (angled)	(L)
1 x Central Roof Support Rafter 2x2 920mm (angled)	(M)
1 x Closed Side Bar Support 2x2 290mm	(N)
2 x Closed Side Bar Support 2x2 190mm	(O)
1 x Closed Side Bar Support 2x2 280mm (angled)	(P)
1 x Closed Side Shelf Support 2x2 290mm	(Q)
1 x Closed Side Vertical Support 2x2 1055mm	(R)
1 x Closed Side Floor Support 2x2 920mm	(S)
1 x Closed Side Roof Support Rafter 2x2 920mm (angled)	(T)

Cladding

1 x Featheredge Front Bar Roof Fascia 1500mm	(U1)
10 x Featheredge Roof Cladding 1500mm	(U2)
19 x Featheredge Rear Wall Cladding 1500mm	(U3)
11 x Featheredge Front Bar Cladding 1500mm	(U4)
11x Featheredge Open Side Cladding 290mm	(U5)
11 x Featheredge Closed Side Cladding 1010mm	(U6)

Tools Required:

Drill driver

Pencil

Tape measure

Spirit level

We recommend a minimum of 2 people to assemble this bar.

THE GRANGE Garden Bar

Fitting Instructions

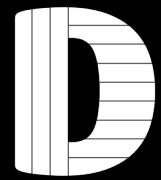

Component List Continued

Bar Top (Front)

- 1 x Bar Top Inner 4x2 1500mm
- 1 x Bar Top Centre 4x2 1500mm
- 1 x Bar Top Outer 4x2 1500mm (2 Notches)
- 1 x Internal Lower Shelf 8x1 1405mm

- (V1)
- (V2)
- (V3)
- (X)

Bar Top (Side)

- 1 x Bar Top Inner 4x2 700mm
- 1 x Bar Top Outer 4x2 700mm (1 Notches)

- (W1)
- (W1)

Fixings*

- 92 x 75mm Green Screws
- 126 x 50mm Green Screws
- Please note—you may receive extra fixings in your kit*

- (Y)
- (Z)

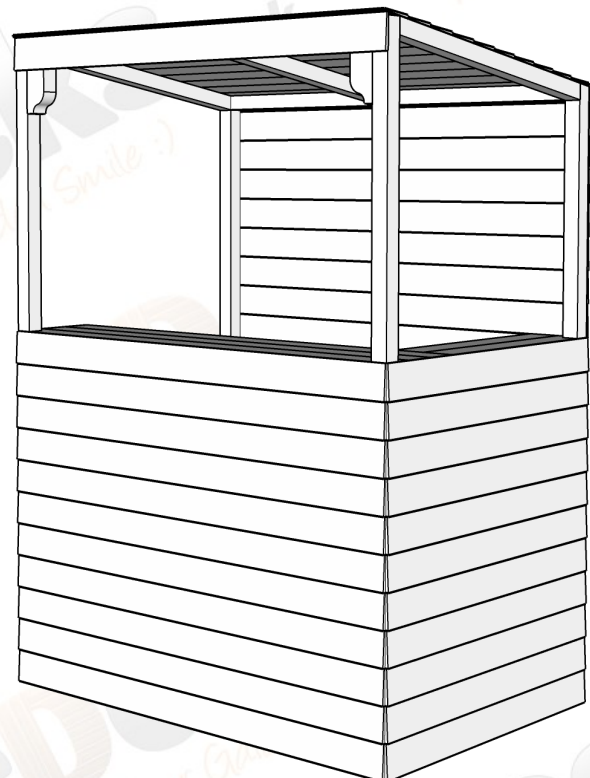
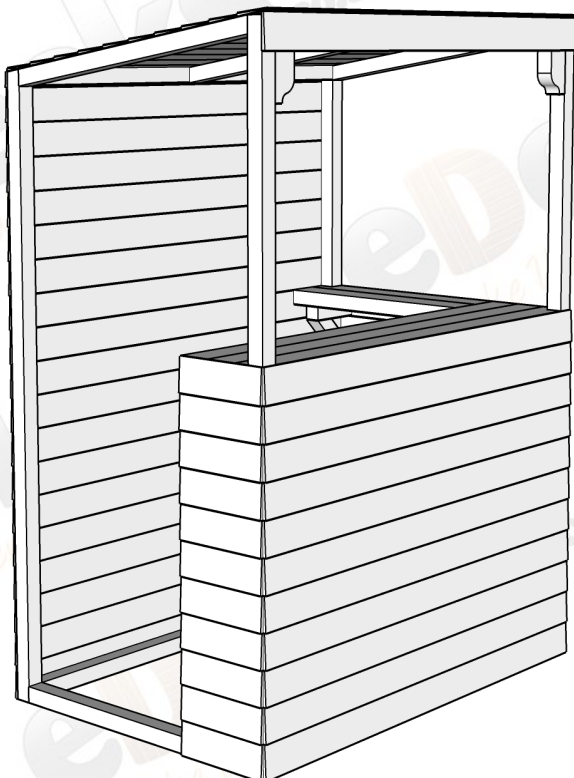

All images are for illustration only. Please see individual item listings for actual item specifications.

THE GRANGE Garden Bar

Fitting Instructions

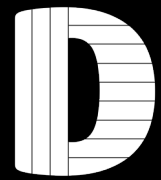

Section 1 – Building the main frame

Step 1

Create a frame using the following components: (A), (E), (K) and (L).

Use 2 x 75mm Green Screws (Y) per join.

Repeat the above using the following components: (A), (E), (S) and (T) to create a second frame.

Use 2 x 75mm Green Screws (Y) per join.

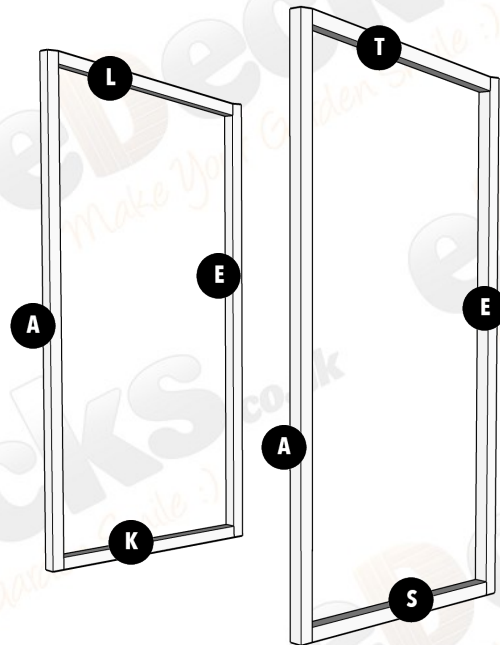

Step 2

Add the floor and roof supports using components (B), (C), (F) and (G) using 2 x 75mm Green Screws (Y) per fixing.

Next, secure in the central roof rafter (M) centrally using 2 x 75mm Green Screws (Y).

Fix the Decorative Supports (D) flush in the corners of the front bars frame.

Drive through the bar posts in to the decorative supports using 2 x 75mm Green Screws (Y) per decorative piece.

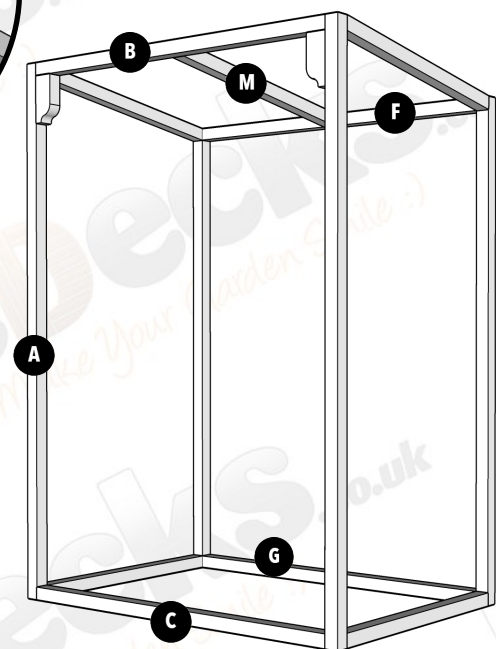
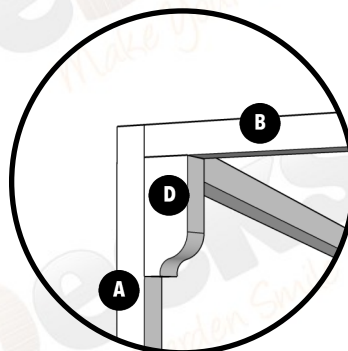

THE GRANGE Garden Bar

Fitting Instructions

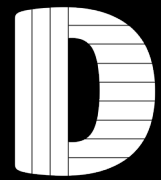

Section 2 – Building the sides

Step 3

Secure the Vertical Support (**J**) by driving 2 x 75mm Green Screws (**Y**) on an angle through the bottom of the support into the Open Side Floor Support (**K**).

*The internal measurement to leave between the Vertical Support (**J**) and the Bar Post (**A**) is 190mm.*

Secure the Bar Support (**H**) flush to the top of the Vertical Support (**J**). Use 2 x 75mm Green Screws (**Y**) at each side. Secure the other side of Bar Support (**H**) to the Bar Front Post (**A**). Repeat this for the Shelf Support (**I**).

The lower shelf's height can be fitted as per your preference.

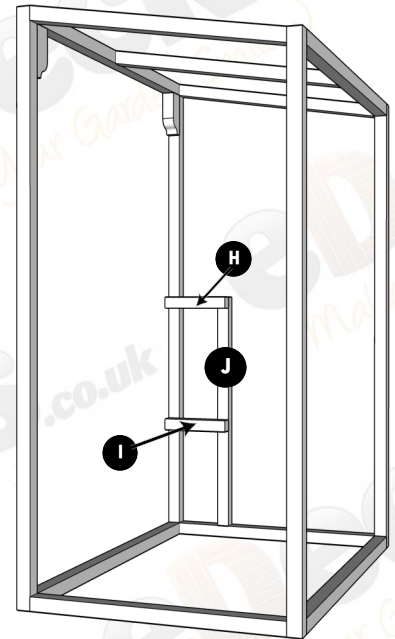
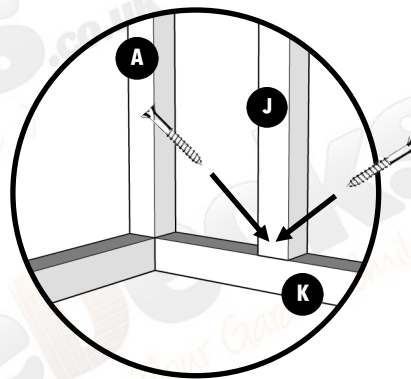

Step 4a

Secure the Vertical Support (**R**) driving 2 x 75mm Green Screws (**Y**) on an angle through the bottom of the support into the Closed Side Floor Support (**S**).

*The internal measurement to leave between the Vertical Support and the Bar Post (**A**) is 190mm.*

Secure the Bar Support (**N**) flush to the top of the Vertical Support (**R**). Use 2 x 75mm Green Screws (**Y**) at each side. Repeat this for the Shelf Support (**Q**) at the same height as decided for the other side using 2 x 75mm Green Screws (**Y**) each side.

Lay the Internal Shelf (**X**) on top of the Shelf Supports (**I**) and (**Q**) then fix in place using 2 x 75mm Green Screws (**Y**) either end.

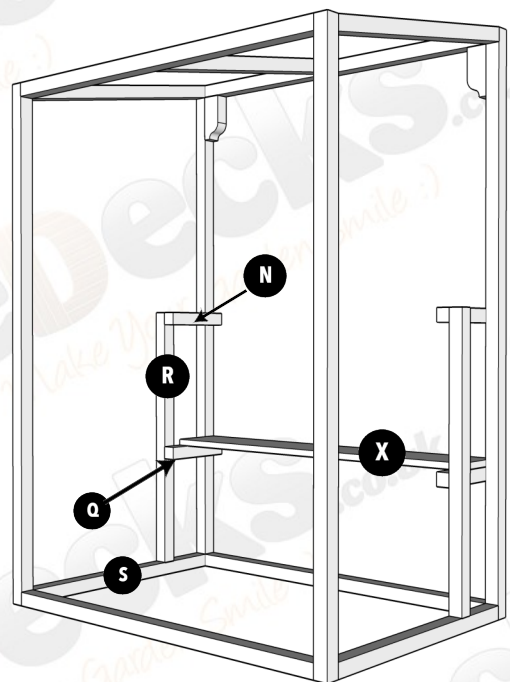

THE GRANGE Garden Bar

Fitting Instructions

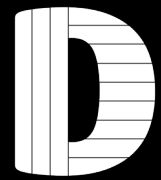

Section 2 – Building the sides

Step 4b

Take the two Bar Supports (**O**) and fix one across the previously fitted Bar Support (**N**) at a level finish using 2 x 75mm Green Screws (**Y**).

Secure the second Closed Side Bar Support (**O**) at the same height but fixing the support to the rear bar post using another 2 x 75mm Green Screws (**Y**).

Use the Angle Cut Bar Support (**P**) to brace the bar support you have just fitted to the bar post using 2 x 75mm Green Screws (**Y**) each side.

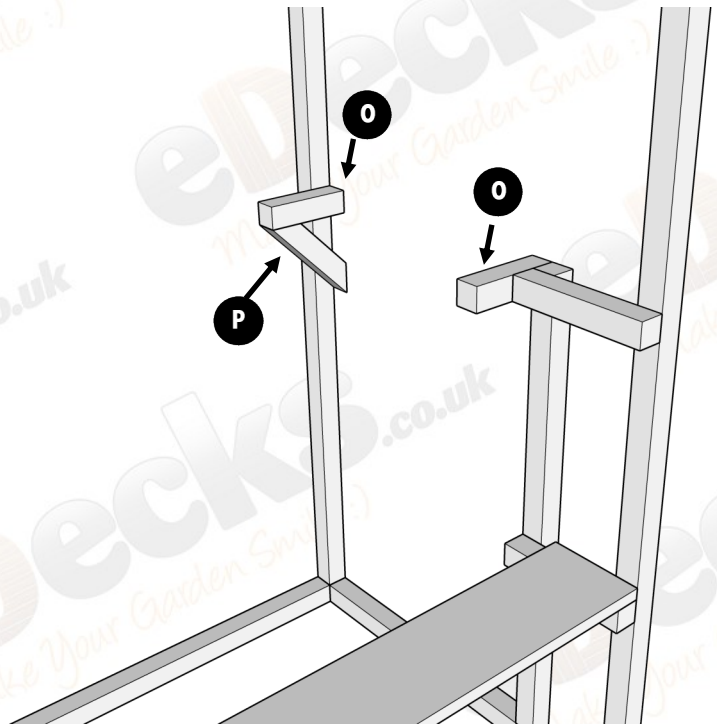

Step 5

Refer to the diagram before starting Step 5.

Place the Bar Top Outer (**V3**) at the front of the bar using the notches as a guide to fit around the front bar posts. Secure in place using 2 x 75mm Green Screws (**Y**) at each end screwing through the bar top and in to the fitted Bar Supports (**H**) and (**N**).

Repeat this for the Bar Top Centre (**V2**) and Inner (**V1**).

When fitting the Bar Top Inner (**V1**) screw one of the 75mm Green Screws (**Y**) through the bar top in to the Vertical Supports (**J**) and (**R**).

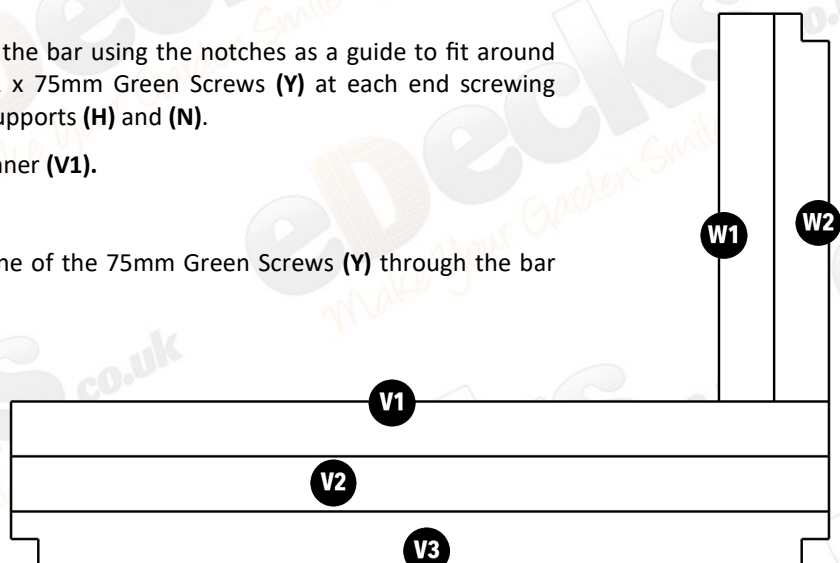

THE GRANGE Garden Bar

Fitting Instructions

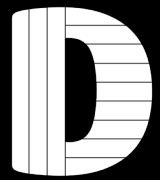

Section 3 – Cladding

Step 6

Working from the bottom and working your way up clad the front of the Bar using the Front Bar Cladding (**U4**) using 2 x 50mm Green Screws per board (**Z**) with a 100mm spacing.

Repeat the above for the Open and Closed sides using claddings (**U5**) and (**U6**).

Fix the Roof Cladding (**U2**) to the roof frame you have made in the earlier steps, working from the rear of the bar up to the front end using 2 x 50mm Green Screws per board (**Z**) with a 100mm spacing, as per previous cladding steps.

Use the remaining cladding to board the rear wall of the bar using Rear Wall Cladding (**U3**), working from the bottom up as per previously using 2 x 50mm Green Screws per board (**Z**) with a 100mm spacing.

To finish off your new bar, attach the Front Bar Fascia (**U1**) across the top of the front of the bar roof.

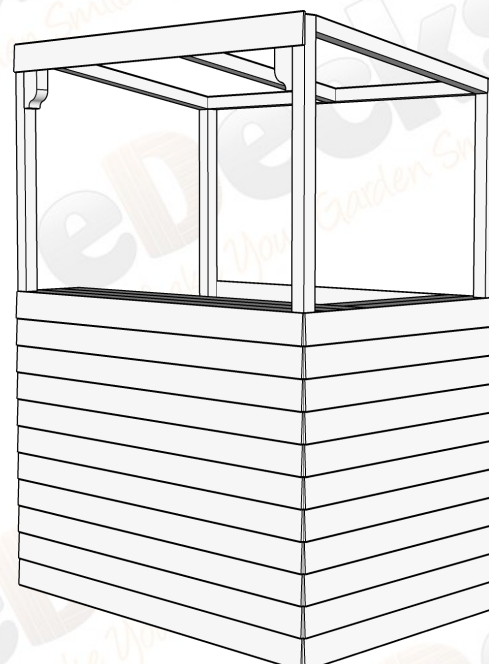
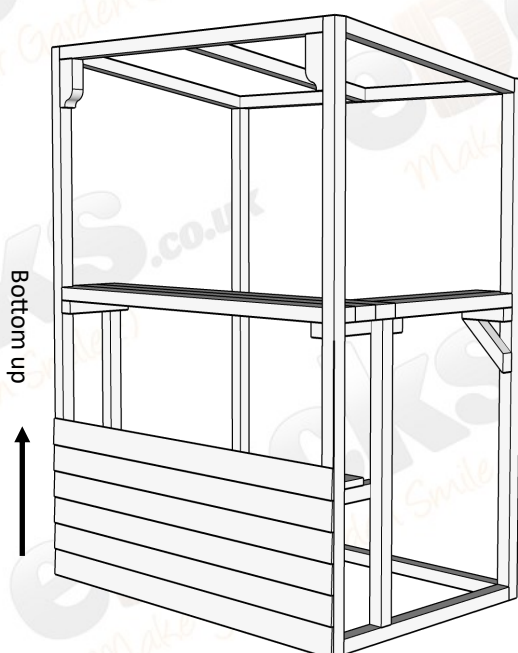
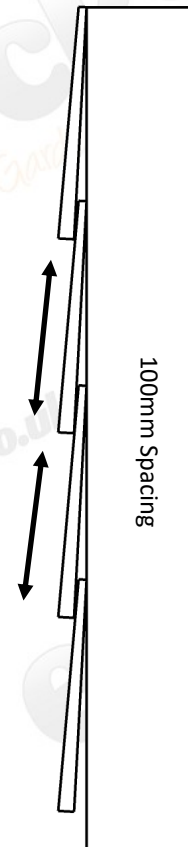

All images are for illustration only. Please see individual item listings for actual item specifications.

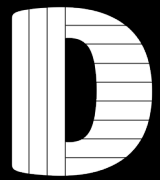

Section 3 – Cladding Continued

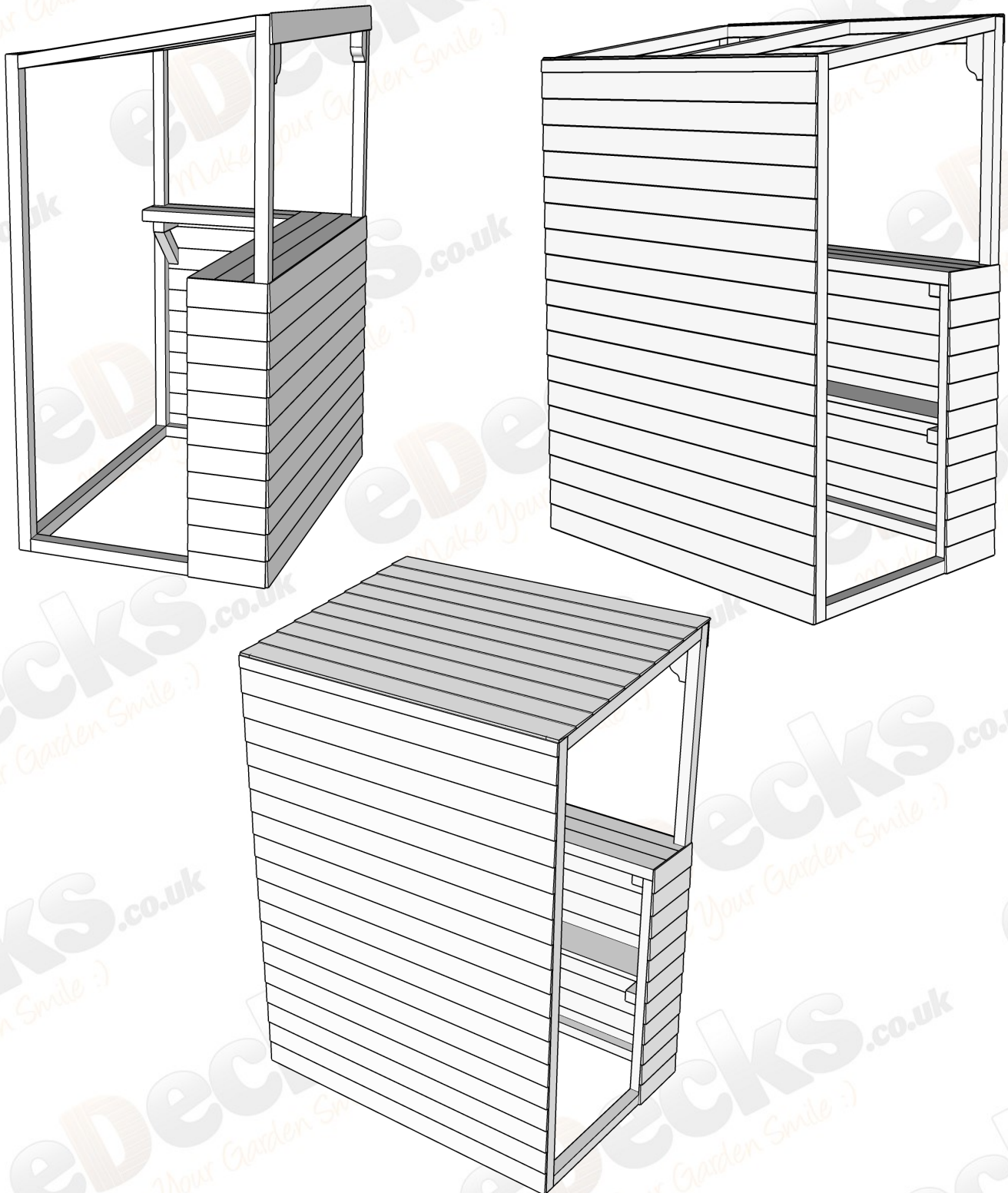

All images are for illustration only. Please see individual item listings for actual item specifications.

THE GRANGE Garden Bar

Fitting Instructions

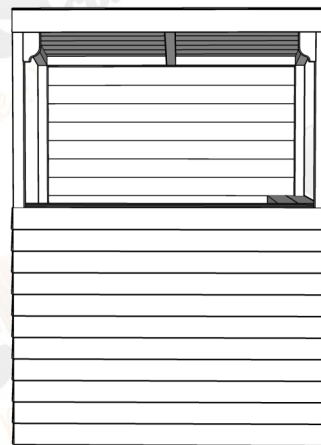
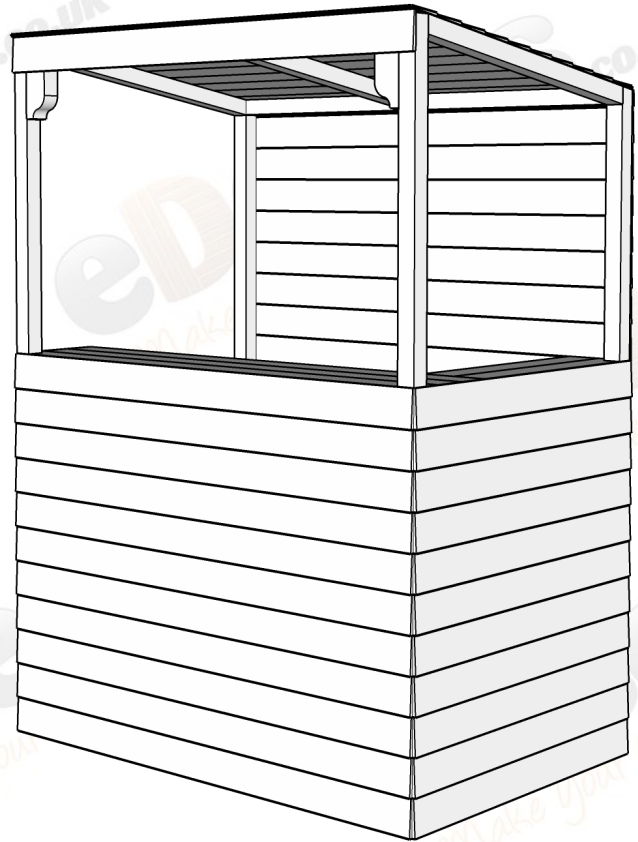
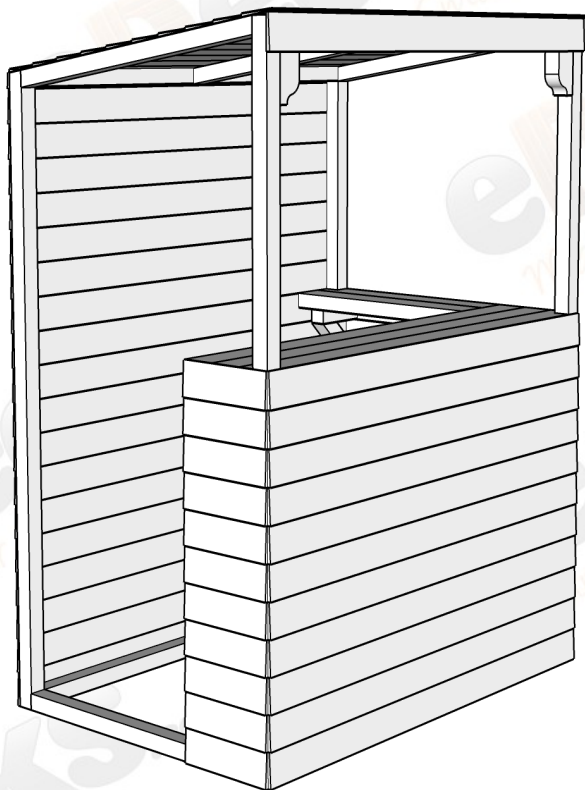
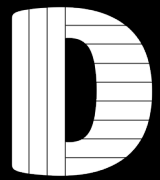

Enjoy your new Garden Bar!

All images are for illustration only. Please see individual item listings for actual item specifications.

Page 8 of 8